

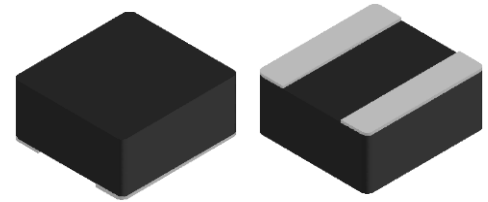

CMI-CMMP4020HL-SERIES

Features

- ▶ Small size, high current and low profile
- ▶ Metal powder molding type for EMC protection.
- ▶ Available tape and reel for auto insertion.
- ▶ Halogen-Free / RoHS compliant.
- ▶ AEC-Q200 qualified



Applications

- ▶ Car navigation, Car stereo and Car accessories, ADAS ECU, In-C-Vehicle camera (View camera, Sensing camera), Automotive communication module.

Dimension (Unit:mm)

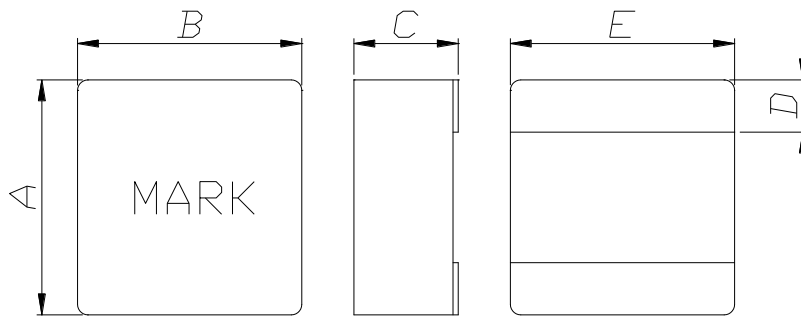

A	B	C	D	E
4.5±0.3	4.2±0.3	2.0 Max.	1.0±0.3	4.2±0.3

Land Pattern (Unit:mm)

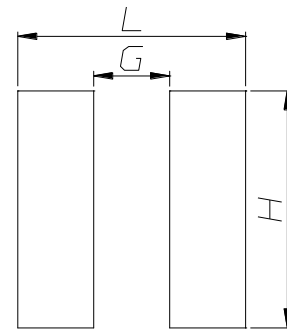

L	G	H
4.8	1.6	5.0

Regulation of part number

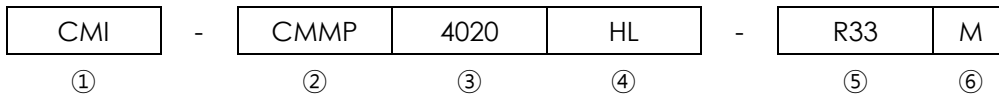

- ① CoilMaster's initial
- ② Series Name : Car Magic Material Power inductor
- ③ Core Size (unit:mm)
- ④ Type
- ⑤ Typical inductance value (0.33uH)
- ⑥ Inductance tolerance (±20%)

• You can also contact us by e-mail : coilmaster@coilmaster.com
 • All specifications are subject to change without notice.
 • Update date : 2021.12.22

Specifications

Part Number	Inductance (μ H) \pm 20%	DCR(mohm) Max(Typ)	IDC1(A) Max(Typ)	IDC2(A) Max(Typ)	Test Frequency (Hz)
CMI-CMMP4020HL-R33M	0.33	8.4(7.0)	15.50(17.50)	9.00(10.00)	1M
CMI-CMMP4020HL-R47M	0.47	12.0(10.0)	14.50(16.50)	8.50(9.50)	1M
CMI-CMMP4020HL-R82M	0.82	18.0(15.0)	11.50(13.50)	7.50(8.00)	1M
CMI-CMMP4020HL-1R0M	1.0	24.0(20.0)	10.00(11.10)	7.00(7.50)	1M
CMI-CMMP4020HL-1R5M	1.5	36.0(30.0)	8.00(9.00)	5.00(5.50)	1M
CMI-CMMP4020HL-2R2M	2.2	48.0(40.0)	6.00(7.00)	4.80(5.30)	1M
CMI-CMMP4020HL-3R3M	3.3	66.0(55.0)	4.50(5.00)	4.00(4.50)	1M
CMI-CMMP4020HL-4R7M	4.7	96.0(80.0)	4.10(4.60)	3.30(3.70)	1M
CMI-CMMP4020HL-6R8M	6.8	156(130)	3.60(4.00)	3.00(3.30)	1M
CMI-CMMP4020HL-8R2M	8.2	158(140)	3.50(3.90)	2.60(2.90)	1M
CMI-CMMP4020HL-100M	10	222(185)	3.20(3.50)	2.40(2.70)	1M
CMI-CMMP4020HL-150M	15	288(240)	2.50(3.00)	1.80(2.00)	1M

- Isat: When based on the inductance change rate (approximately 30% below in the initial value)
- Itemp: When based on the temperature increase (Temperature increase of approximately 40°C by self heating)
- Operating Temperature Range(including self temperature) : -40°C ~ +150 °c

Note 1 : Circuit design, component placement, PCB trace size and thickness, airflow and other cooling. Provision all affect the part Temperature. Part temperature should be verified in the end application.

▪ You can also contact us by e-mail : coilmaster@coilmaster.com

- All specifications are subject to change without notice.
- Update date : 2021.12.22

www.coilmaster.com

Electrical characteristics

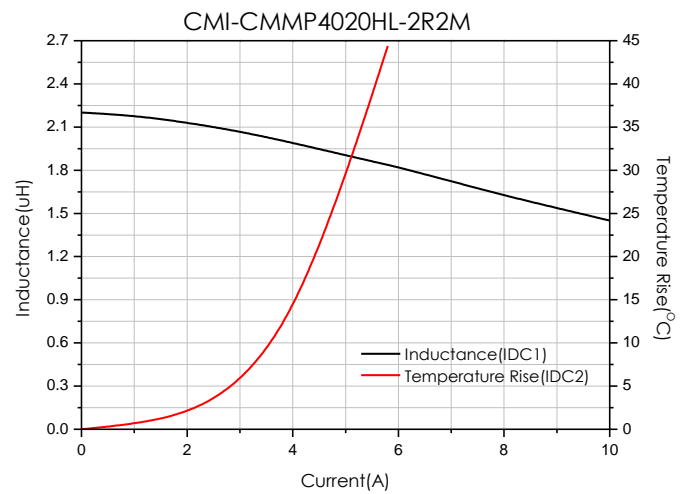
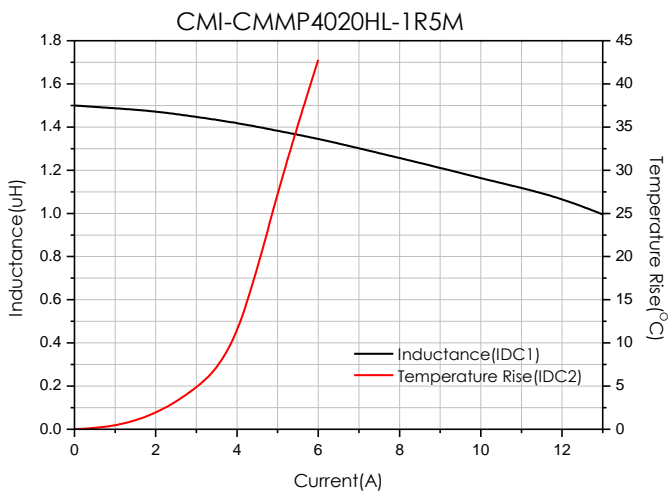
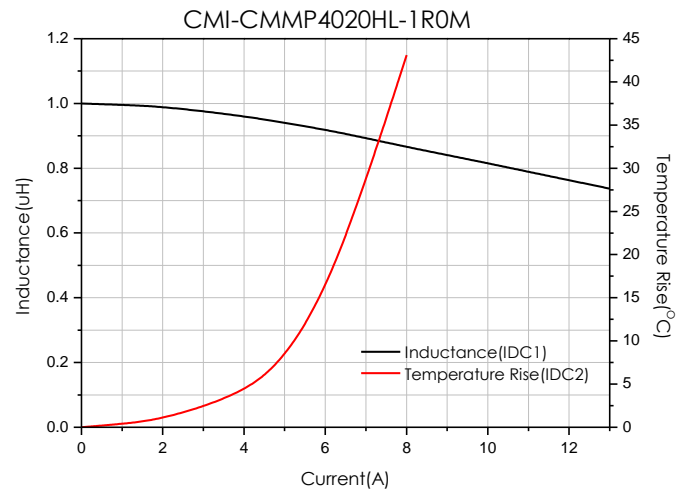
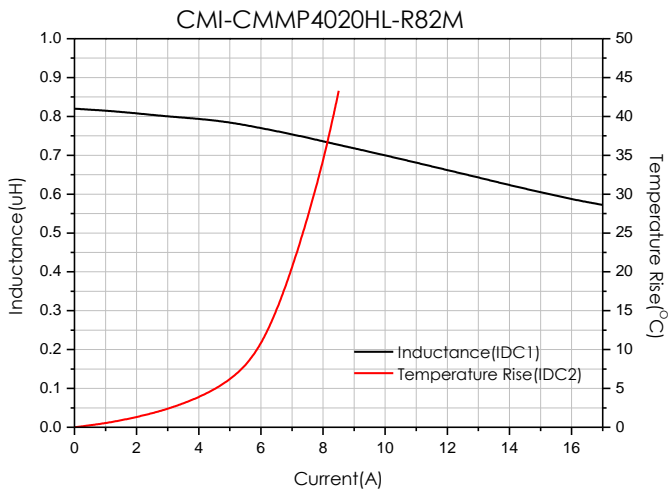
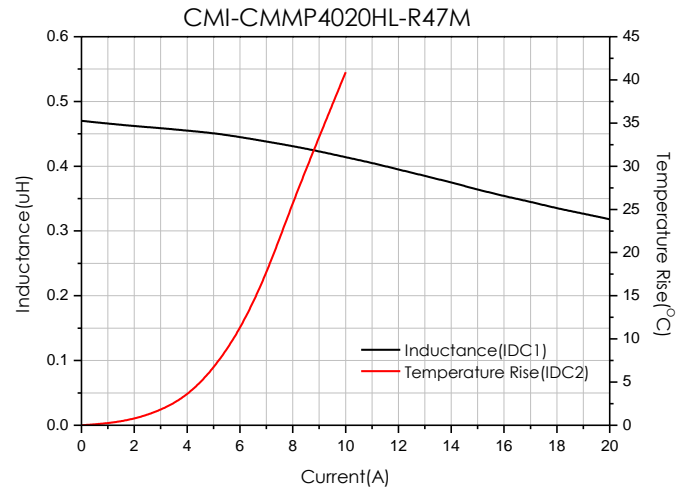
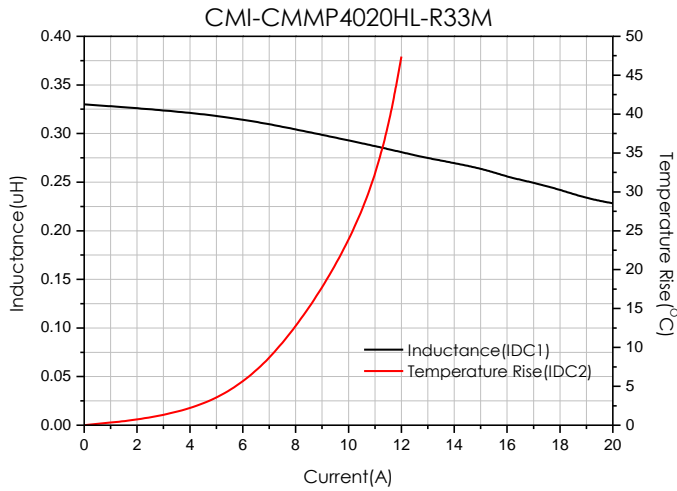

- You can also contact us by e-mail : coilmaster@coilmaster.com
- All specifications are subject to change without notice.
- Update date : 2021.12.22

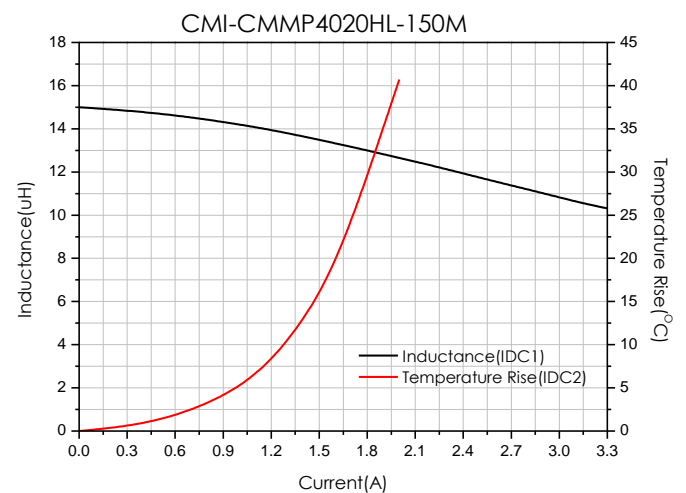
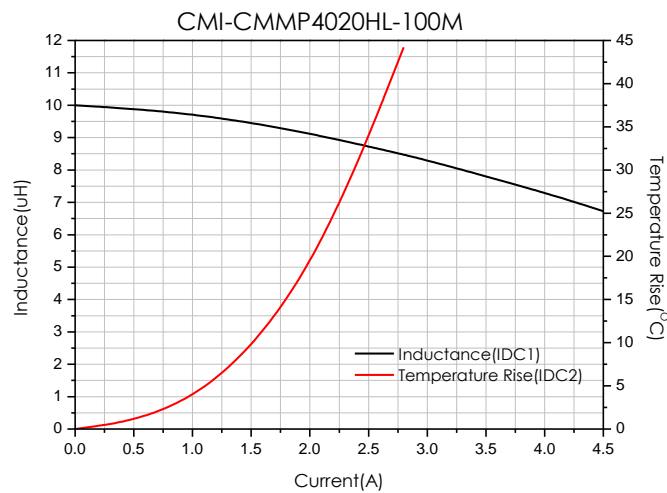
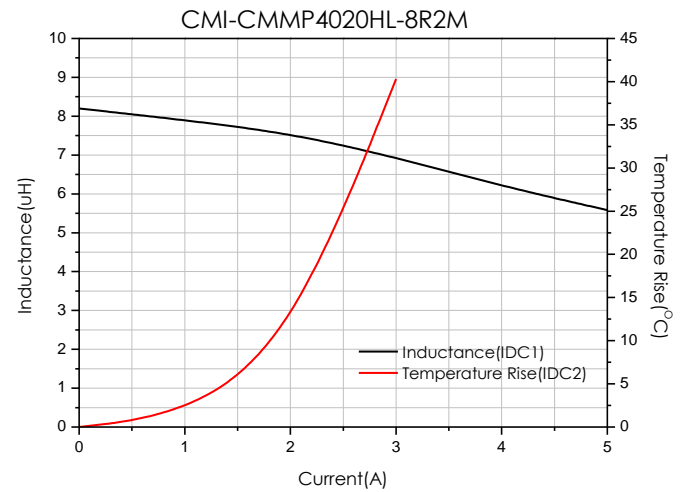
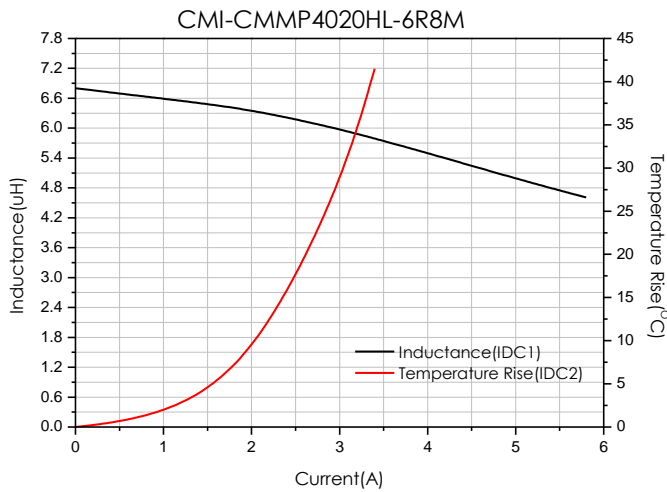
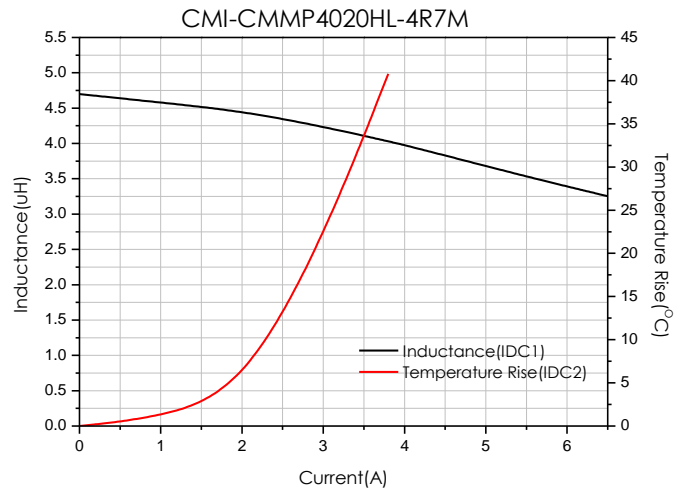
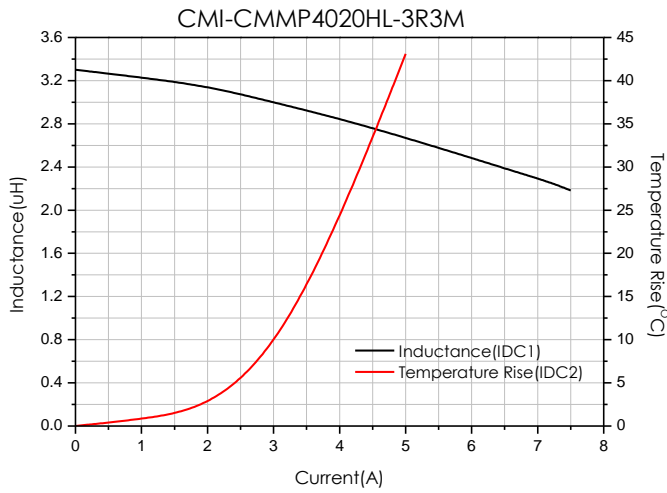

- You can also contact us by e-mail : coilmaster@coilmaster.com
- All specifications are subject to change without notice.
- Update date : 2021.12.22

Packaging

(1) Package quantity : 3,000 (pcs/reel)

(2) Reel Dimensions (unit:mm)

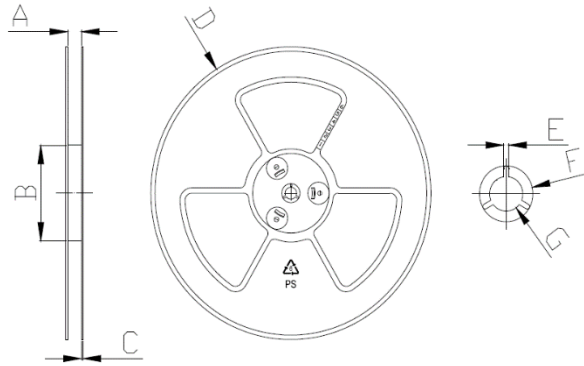

A	B	C	D	E	F	G
12.50	100.0	2.00	330.0	1.90	21.00	13.00
+1.00	+1.50	+0.10	+1.00	+0.40	+0.40	+0.40
-1.00	-1.50	-0.10	-1.00	-0.40	-0.40	-0.40

(3) Tape Dimensions

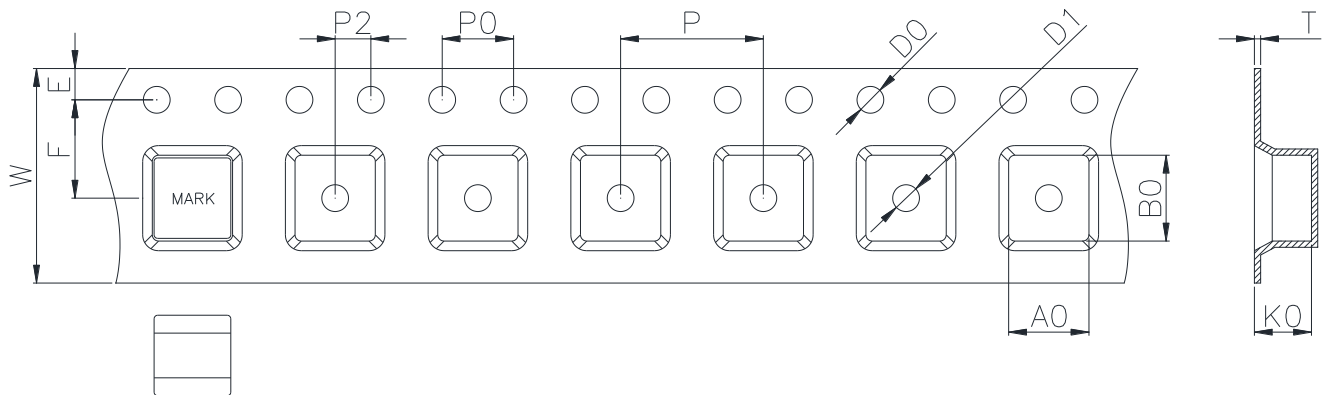

W	A	B	K	E	F	P	P1	P2	D	T
12.00	4.60	4.90	2.20	1.75	5.50	8.00	4.00	2.00	1.50	0.35
+0.30	+0.10	+0.10	+0.10	+0.15	+0.10	+0.10	+0.10	+0.10	+0.10	+0.05
-0.10	-0.10	-0.10	-0.10	-0.10	-0.10	-0.10	-0.10	-0.10	-0.00	-0.05

Ilisan Sales Office (KOREA) +82)31-904-1444
 Shenzhen Sales Office (CHINA) +86)755-8663-6929
 Hungary Sales office (EUROPE) +36)30-913-7706

H.K Sales Office (HONGKONG) +852)2711-5551
 LA Sales Office (USA) +1)866-446-3586

• You can also contact us by e-mail : coilmaster@coilmaster.com

- All specifications are subject to change without notice.
- Update date : 2021.12.22

www.coilmaster.com