

CMI-CMMPP6030LH-N SERIES

Features

- ▶ High current and low profile
- ▶ Metal powder molding type for EMC protection.
- ▶ Available tape and reel for auto insertion.
- ▶ Halogen-Free / RoHS compliant.
- ▶ AEC-Q200 qualified.

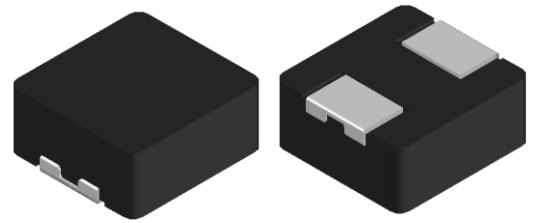

Applications

- ▶ Equipment using for automobiles (ECM, Airbags, Headlights, Electronic Power steering, Motors, ABS, other)

Dimension (Unit:mm)

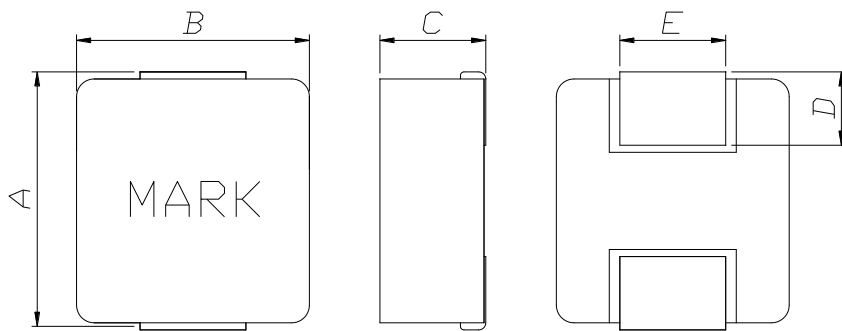

A	B	C	D	E
6.95±0.45	6.6±0.25	3.0 Max	1.8±0.3	3.0±0.3

Land Pattern (Unit:mm)

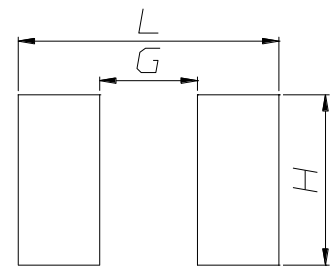

L	G	H
8.4	3.7	3.5

Regulation of part number

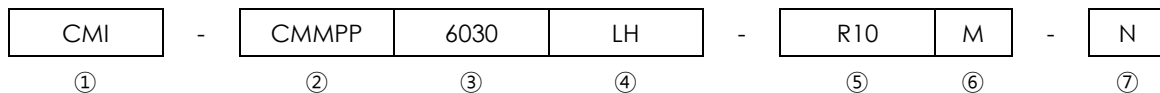

- ① CoilMaster's initial
- ② Series Name : Car Magic Material Pin type Power inductor
- ③ Core Size (unit:mm)
- ④ Material
- ⑤ Typical inductance value (0.1uH)
- ⑥ Inductance tolerance (±20%)
- ⑦ Revision (N)

• You can also contact us by e-mail : coilmaster@coilmaster.com
 • All specifications are subject to change without notice.
 • Update date : 2021.04.29

Specifications

Part Number	Inductance (uH) $\pm 20\%$	DCR(mohm) Max(Typ)	IDC1(A) Max(Typ)	IDC2(A) Max(Typ)	Test Frequency (Hz)
CMI-CMMPP6030LH-R10M-N	0.10	1.8(1.4)	57.00(67.00)	22.00(24.00)	1M
CMI-CMMPP6030LH-R15M-N	0.15	2.0(1.6)	45.00(50.00)	21.50(23.50)	1M
CMI-CMMPP6030LH-R22M-N	0.22	2.2(1.8)	42.00(45.00)	20.50(21.00)	1M
CMI-CMMPP6030LH-R33M-N	0.33	3.6(3.0)	35.00(38.00)	16.80(17.50)	1M
CMI-CMMPP6030LH-R47M-N	0.47	4.8(4.0)	29.00(32.00)	14.50(15.50)	1M
CMI-CMMPP6030LH-R68M-N	0.68	6.6(5.5)	26.00(29.00)	13.50(14.50)	1M
CMI-CMMPP6030LH-1R0M-N	1.0	10.8(9.0)	20.00(23.00)	9.00(10.00)	1M
CMI-CMMPP6030LH-1R5M-N	1.5	15.0(12.5)	19.00(21.00)	8.50(9.00)	1M
CMI-CMMPP6030LH-2R2M-N	2.2	15.6(13.0)	13.50(15.00)	7.50(8.00)	1M
CMI-CMMPP6030LH-3R3M-N	3.3	29.0(24.0)	12.00(13.00)	6.30(6.70)	1M
CMI-CMMPP6030LH-4R7M-N	4.7	36.0(30.0)	9.50(10.50)	6.00(6.50)	1M
CMI-CMMPP6030LH-5R6M-N	5.6	60.0(50.0)	8.50(9.50)	5.80(6.30)	1M
CMI-CMMPP6030LH-6R8M-N	6.8	62.4(52.0)	8.00(9.00)	5.60(6.20)	1M
CMI-CMMPP6030LH-8R2M-N	8.2	64.0(54.0)	6.50(7.20)	4.10(4.40)	1M
CMI-CMMPP6030LH-100M-N	10	76.0(64.0)	6.00(7.00)	4.00(4.10)	1M
CMI-CMMPP6030LH-150M-N	15	114(95.0)	4.50(5.00)	3.20(3.50)	1M
CMI-CMMPP6030LH-220M-N	22	150(125)	3.80(4.30)	2.90(3.20)	1M

- IDC1: When based on the inductance change rate (approximately 30% below in the initial value)
- IDC2: When based on the temperature increase (Temperature increase of approximately 40°C by self heating)
- Operating Temperature Range(including self temperature) : -40°C ~ +165 °C

Note 1 : Circuit design, component placement, PCB trace size and thickness, airflow and other cooling. Provision all affect the part Temperature. Part temperature should be verified in the end application.

▪ You can also contact us by e-mail : coilmaster@coilmaster.com

- All specifications are subject to change without notice.
- Update date : 2021.04.29

www.coilmaster.com

Electrical characteristics

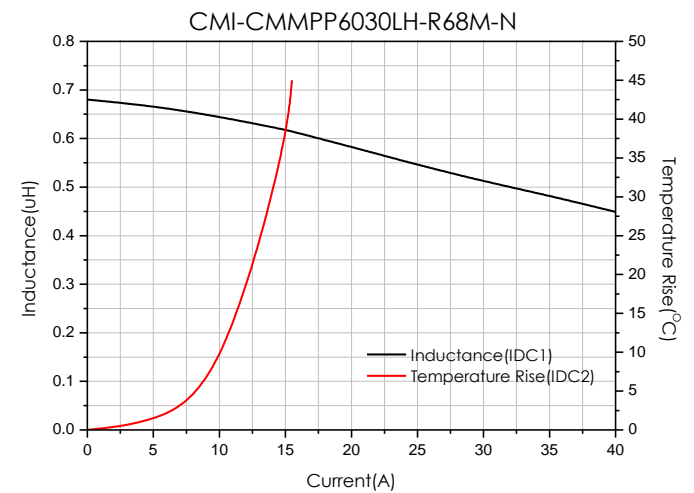
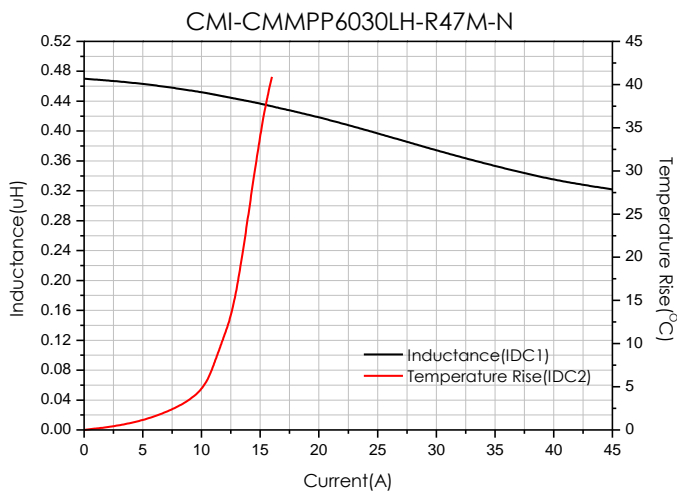
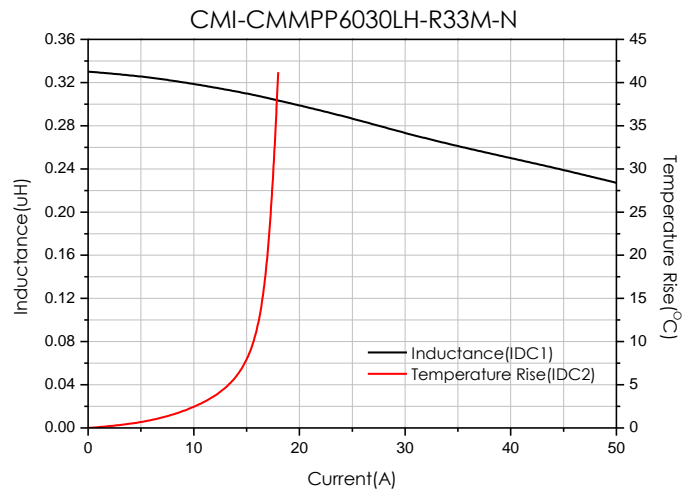
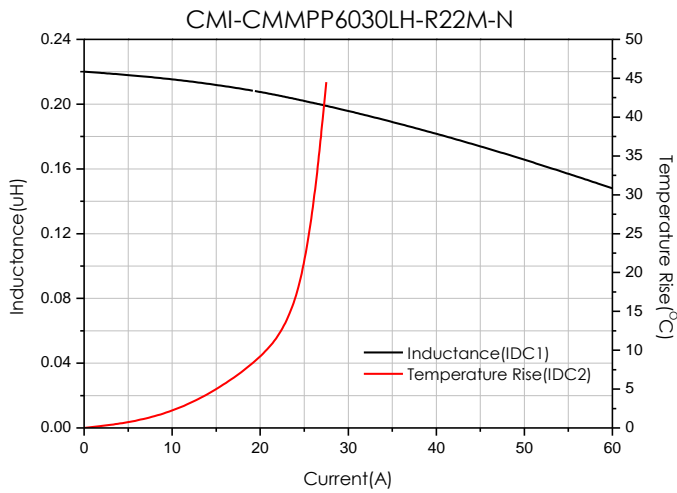
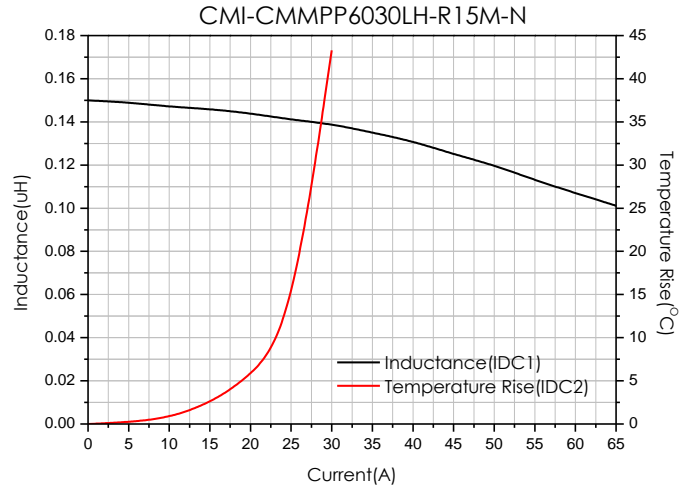
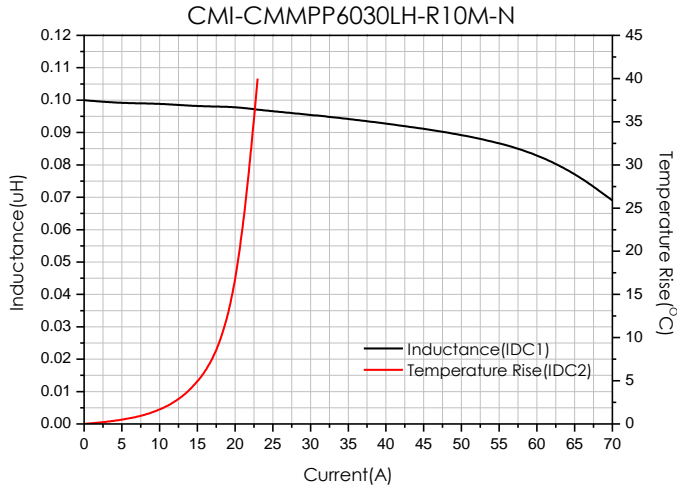

- You can also contact us by e-mail : coilmaster@coilmaster.com
- All specifications are subject to change without notice.
- Update date : 2021.04.29

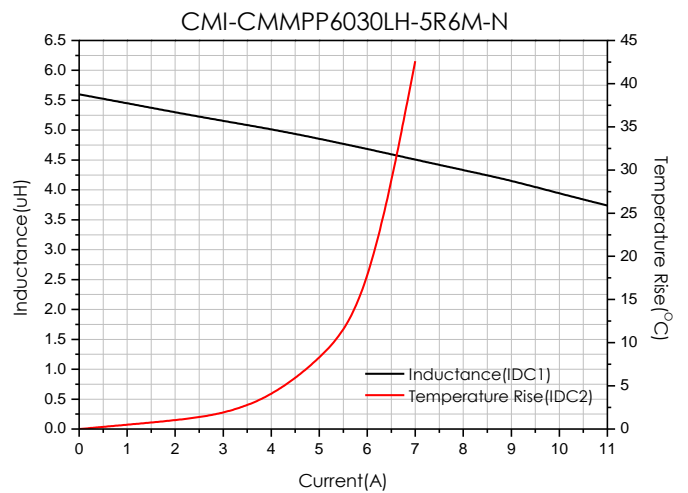
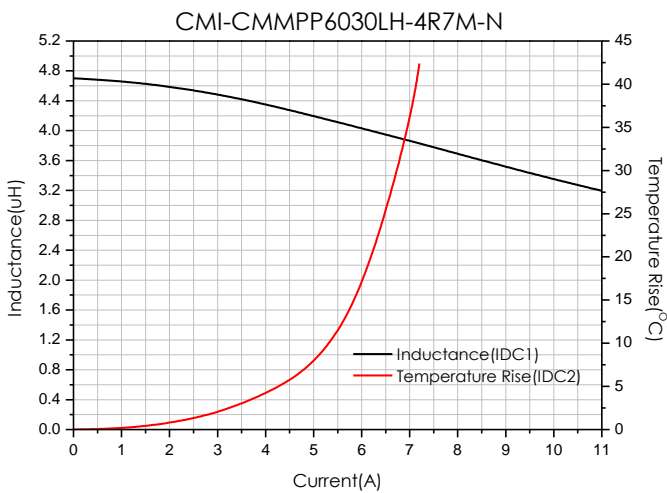
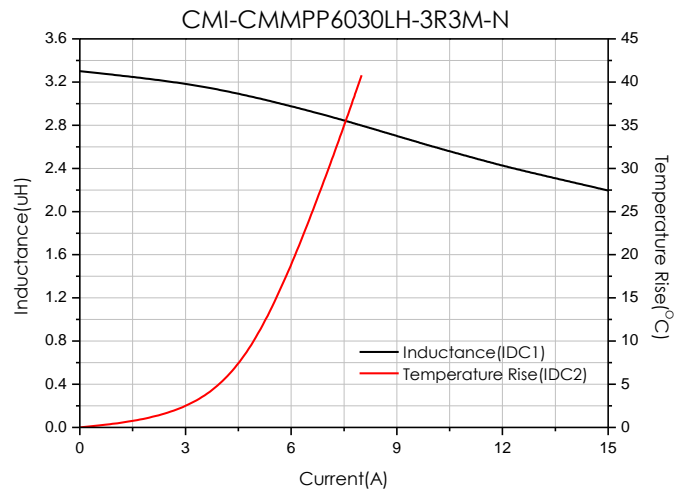
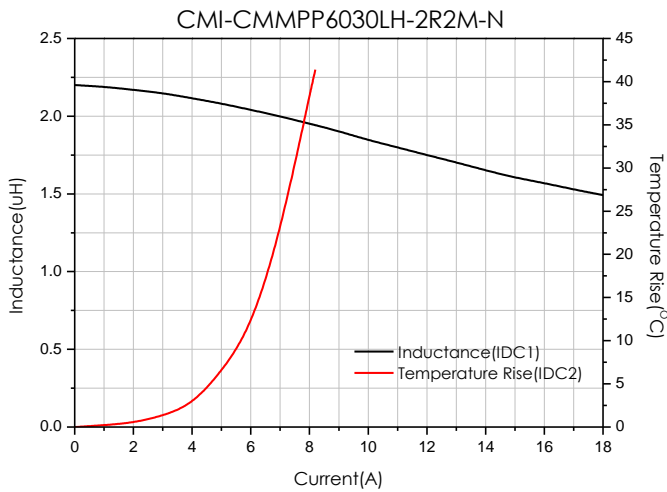
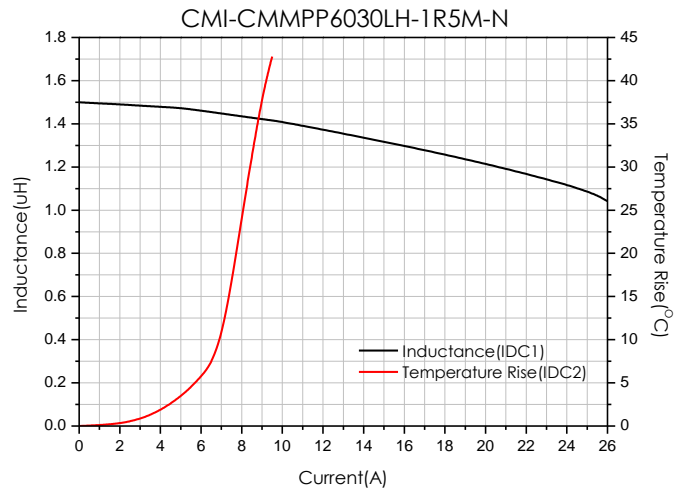
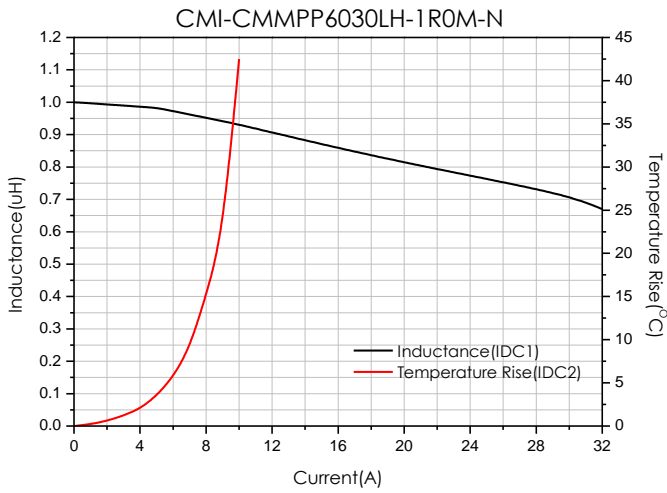

- You can also contact us by e-mail : coilmaster@coilmaster.com
- All specifications are subject to change without notice.
- Update date : 2021.04.29

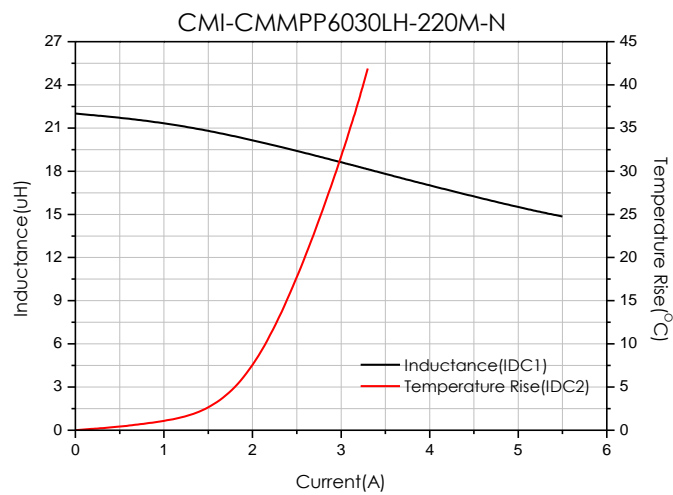
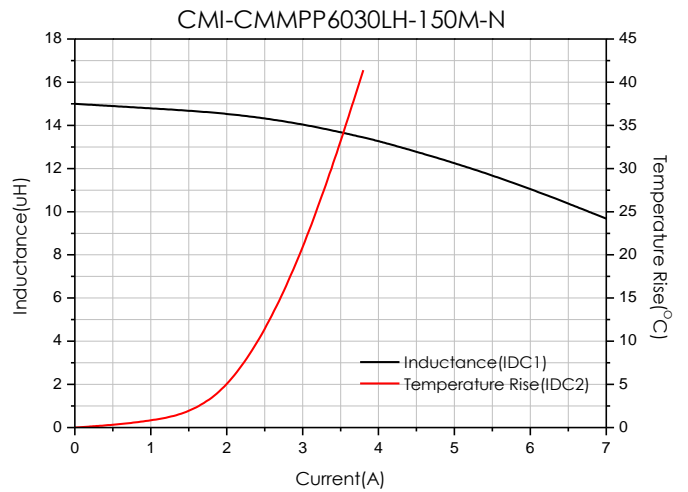
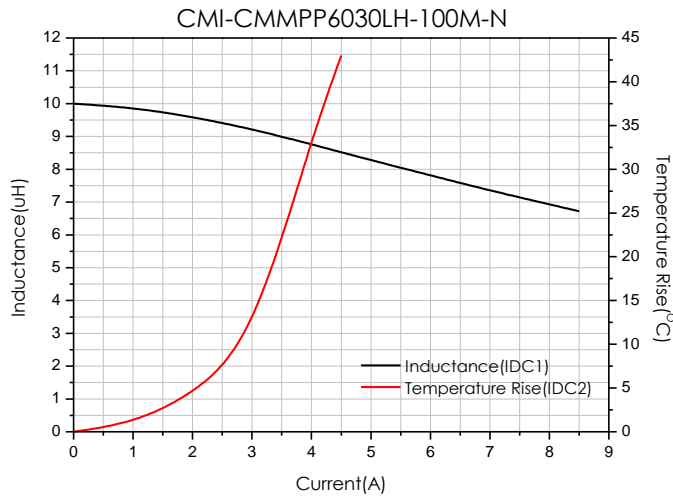
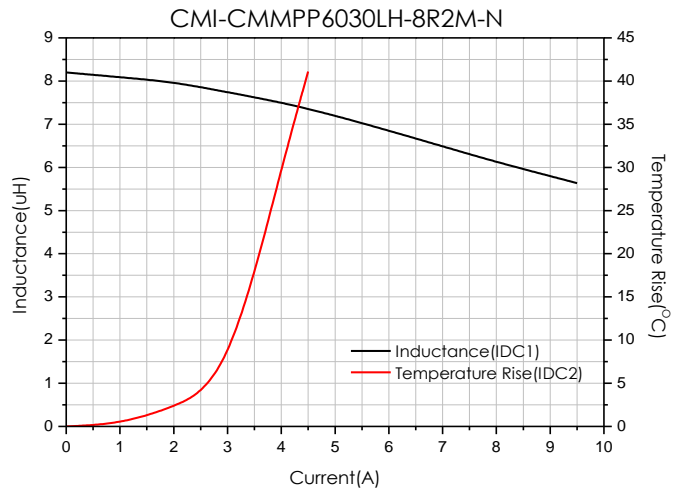
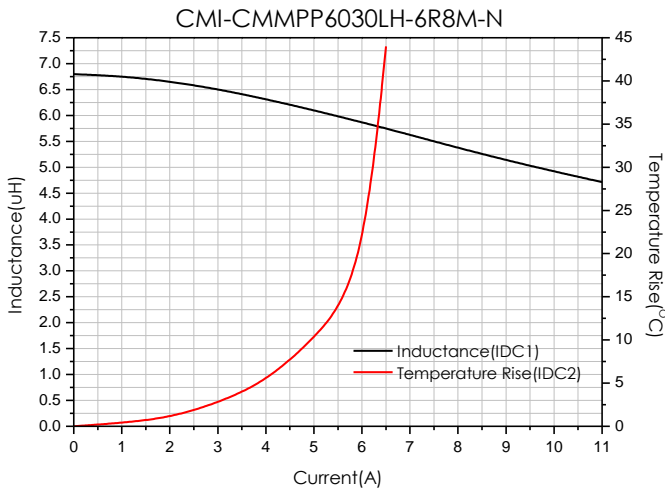

- You can also contact us by e-mail : coilmaster@coilmaster.com
- All specifications are subject to change without notice.
- Update date : 2021.04.29

Packaging

(1) Package quantity : 1,000 (pcs/reel)

(2) Reel Dimensions (unit:mm)

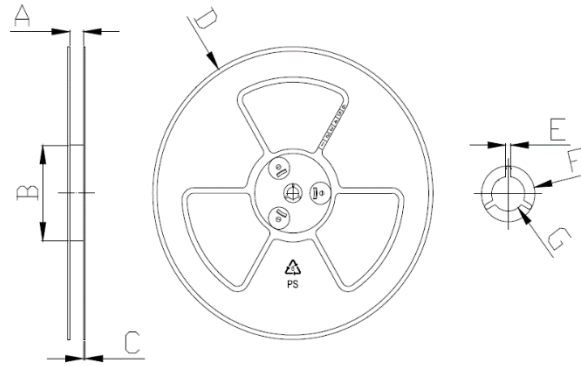

A	B	C	D	E	F	G
16.50	100.0	2.00	330.0	2.30	21.50	13.00
+0.50	+1.00	+0.10	+3.00	+0.30	+0.30	+0.50
-0.50	-1.00	-0.10	-3.00	-0.30	-0.30	-0.20

(3) Tape Dimensions

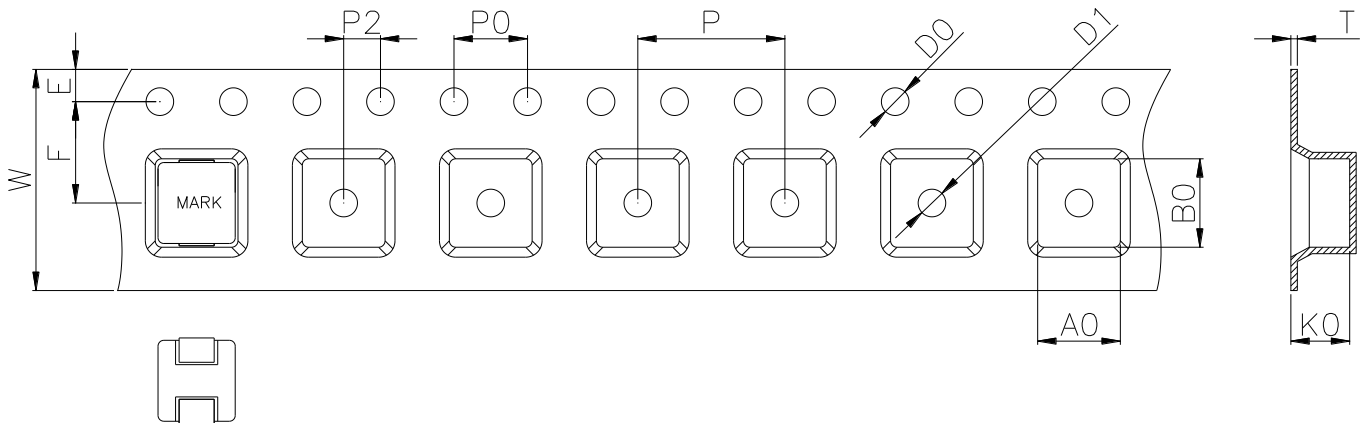

W	A0	B0	K0	E	F	P	P0	P2	D0/D1	T
16.00	7.00	7.50	3.20	1.75	7.50	12.00	4.00	2.00	1.50	0.35
+0.30	+0.10	+0.10	+0.10	+0.10	+0.10	+0.10	+0.10	+0.10	+0.10	+0.05
-0.10	-0.10	-0.00	-0.10	-0.10	-0.10	-0.10	-0.10	-0.10	-0.00	-0.05

Ilsan Sales Office (KOREA) +82)31-904-1444
 Shenzhen Sales Office (CHINA) +86)755-8663-6929
 Hungary Sales office (EUROPE) +36)30-913-7706

H.K Sales Office (HONGKONG) +852)2711-5551
 LA Sales Office (USA) +1)866-446-3586

• You can also contact us by e-mail : coilmaster@coilmaster.com

- All specifications are subject to change without notice.
- Update date : 2021.04.29

www.coilmaster.com